

Laser Technology, Inc.

# TruPulse<sup>®</sup> 200L

## User's Manual



© LTI 2018 TruPulse 200L 0144873



 **LASER<sup>INC</sup>  
TECHNOLOGY**  
Measurably Superior<sup>®</sup>

**Copyright Notice:**

Information in this document is subject to change without notice and does not represent a commitment on the part of Laser Technology Inc. No part of this manual may be reproduced in any form or by any means, electronic or mechanical, including photocopying, recording, or information storage and retrieval systems, for any purpose other than the purchaser's personal use, without the express written consent of Laser Technology, Inc.

Copyright © Laser Technology, Inc., 2013-2018. All rights reserved.

Fourth Edition: April 2018

**Patents:**

This product is covered by the following issued U.S. Patents:  
7,920,080 ; 7,619,548.

**Trademarks:**

Criterion and TruPulse are trademarks of Laser Technology, Inc.

**LTI Contact Information:**

Laser Technology, Inc.  
6912 South Quentin St.  
Centennial, CO 80112-3921 USA

Phone: 1-303-649-1000  
1-800-790-7364 (USA and Canada)

Fax: 1-303-649-9710  
Web Site: [www.lasertech.com](http://www.lasertech.com)

**TruPulse 200L Reference Information:**

Record information about your TruPulse 200L in the table below.

	<i>You can find this value:</i>	<i>Value</i>
Serial Number	On the serial number sticker affixed to the TruPulse 200L or see <a href="#">page 13</a> for information.	
Firmware Revision Number	See <a href="#">page 13</a> for information.	

## Table of Contents

Precautions .....	2
Section 1 - Introducing the LTI TruPulse 200L .....	3
Operating Modes .....	3
Unpacking the TruPulse 200L .....	4
Basic Package .....	4
Compatible Accessories.....	4
Understanding How the TruPulse 200L Works .....	4
LCD Display .....	4
Laser Range Sensor .....	4
TruTargeting .....	5
Tilt Sensor .....	6
Digital Processor.....	6
Section 2 - Quick Start .....	7
Section 3 - Basic Operations.....	8
Battery .....	8
Installation .....	8
Low Battery Warning .....	8
Buttons .....	9
Powering OFF the TruPulse 200L .....	9
Display Indicators.....	10
Display Indicator Test.....	12
Error Codes.....	12
Firmware Revision Number and Serial Number.....	13
Neck Strap .....	14
Units of Measure .....	15
Section 4 - Measurement Modes.....	16
Distance Measurements .....	16
Notes about Measurements .....	17
Inclination Measurements.....	17
Percent Slope .....	17
Height Routine.....	18
2D Missing Line Routine.....	20
Section 5 - Target Modes .....	22
Section 6 - Care & Maintenance .....	24
Section 7 - Specifications .....	25
Section 8 - LTI Limited Warranty.....	26
Section 9 - Main Display LCD Characters .....	28

## Precautions

### **Avoid staring directly at the laser beam for prolonged periods.**



This product complies with IEC 60825-1, 2014-5, Ed. 3.0 and complies with FDA performance standards for laser products except for deviations pursuant to Laser Notice 50, Dated June 24, 2007.

The TruPulse® 200L is designed to meet FDA eye safety requirements and is classified as eye-safe to Class 1 limits, which means that virtually no hazard is associated with directly viewing the laser output under normal conditions. As with any laser device, however, reasonable precautions should be taken in its operation. It is recommended that you avoid staring into the transmit aperture while firing the laser. The use of optical instruments with this product may increase eye hazard.

### **Never attempt to view the sun through the scope.**

Looking at sun through the scope may permanently damage your eyes.

### **Never point the unit directly at the sun.**

Exposing the lens system to direct sunlight, even for a brief period, may permanently damage the internal components.

### **Avoid direct sun exposure on the eyepiece.**

Exposing the eyepiece to direct sunlight can damage the internal display.

### **Do not expose the instrument to extreme temperatures.**

TruPulse® 200L components are rated for a temperature range of -4 to +140° F (-20 to +60° C). Do not expose the instrument to temperatures outside this range whether in use or in storage.

## Section 1 - Introducing the LTI TruPulse 200L

Congratulations on the purchase of your TruPulse 200L, a cost-effective professional rangefinder. This compact and lightweight laser is a flexible tool for your measurement needs.

Features of the TruPulse:

- New graphic display makes it easy to use.
- Crystal clear optics and the heads up display lets you keep your eye on the target.
- The laser sensor and integrated tilt sensor measure slope distance, horizontal distance, vertical distance and inclination.
- The Target Mode allows you to select or eliminate targets; which helps you take the most accurate measurement possible in a variety of field conditions.
- Flexible, 2 or 3-point height routines and 2-dimensional Missing Line routine with auto sequencing.

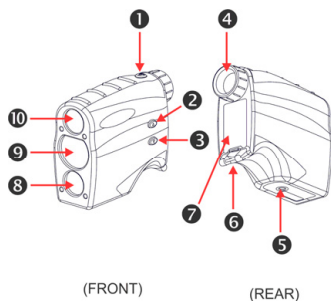

1. FIRE button (power ON)
2. ▲ (UP) button
3. ▼ (DOWN) button
4. Eyepiece
5. Tripod / Monopod mount
6. Attachment Point (for neck strap and Foliage Filter Lens)
7. Battery Compartment Cover
8. Transmit Lens
9. Receive Lens
10. Viewing Objective

Figure #1

### Operating Modes

**Measurement Modes**  
 Slope Distance Vertical  
 Distance Horizontal  
 Distance Inclination  
 3-Point Height Routine  
 2D Missing Line Routine

**Target Modes**  
 Standard  
 Continuous  
 Closest  
 Farthest  
 Filter

**System Setup Mode**  
 Units Selection

## **Unpacking the TruPulse 200L**

When you unpack the TruPulse 200L, check to make sure that you received everything that you ordered, and that it all arrived undamaged.

### **Basic Package**

- TruPulse 200L
- Carrying Case
- Lens Cloth
- Neck Strap

### **Compatible Accessories**

- Foliage Filter
- Tripod

-  This manual is available for download from Laser Technology's Website.
- To learn more about any of the items listed above, please contact your LTI Sales Representative or an Authorized LTI Distributor.

## **Understanding How the TruPulse 200L Works**

The TruPulse 200L consists of a laser range sensor, an integrated tilt sensor, and a digital processor. The TruPulse 200L has three buttons that access the unit's internal software, which controls the integrated sensors.

### **LCD Display**

A liquid crystal display (LCD) is mounted within the optical system and when activated, displays a reticle for targeting, yards / meters, and the display indicators. Inherent in the manufacturing process are small black spots that appear in the optical system. These are a natural characteristic of the LCD and cannot be fully eliminated in the manufacturing process. These small black spots do not affect the distancing performance of the unit.

### **Laser Range Sensor**

The laser range sensor emits invisible, eye safe, infrared energy pulses. The TruPulse 200L determines distance by measuring the time it takes for each pulse to travel from the rangefinder to the target, and back. The  indicator is displayed whenever the laser is being transmitted. The laser may be active for a maximum of 5 seconds. Once the target is acquired or the laser has timed out, you can release the FIRE button. The TruPulse 200L has a broad spectrum of sensitivity and can work with both reflective and non-reflective targets.

## TruTargeting

The TruPulse automatically provides the best accuracy and acquisition distance to a given target. Maximum measurement distance varies with target quality and environmental conditions. When shooting to a target, the maximum measurement distance is approximately 5,740 feet, (1750 m).

When selecting a target, you should consider the following:

- *Color*: The brighter the color, the longer the range.
- *Finish*: Shiny finishes provide longer range than dull finishes.
- *Angle*: Shooting perpendicular to a target provides better range than shooting to a target at a sharp angle.
- *Lighting Conditions*: Overcast skies will increase the unit's maximum range, and sunny skies will decrease the unit's maximum range.

Target quality has an effect on the precision of measurements. A high quality target will result in a measurement that includes one decimal place (tenths). A low quality target will result in a measurement that is a whole number.







Examples:

- *120* feet (meters / yards) indicates a measurement was made to a low quality target.
  - Accuracy:  $\pm 3$  ft ( $\pm 1$  m).
- *120.0* feet (meters / yards) indicates a measurement was made to a high quality target.
  - Feet are shown in half-unit increments (.0 or .5).
  - Meters and Yards are shown in tenth-unit increments (.0 - .9).
  - Accuracy:  $\pm 1.6$  feet ( $\pm 0.5$  m).

## Tilt Sensor

The integrated tilt sensor measures vertical angles that the TruPulse 200L uses to calculate height and elevation and to determine slope-reduced horizontal distances. The instrument held level is at  $0^\circ$ , and is rotated up through  $+90^\circ$  and down through  $-90^\circ$ .

- The laser is not active in the Inclination  Measurement Mode.
- Generally, the inclination is measured when you press . However in (1) the Continuous Target Mode and (2) in the Height Measurement Mode, the inclination reading appears in the Main Display and the display updates as your aiming point changes as long as you press . In these two situations, the measured inclination is based upon the aiming point when you release .

## Digital Processor

The TruPulse 200L includes LTI's proprietary ASIC chip (Application-Specific Integrated Circuit). The ASIC chip combined with high-speed CPU processing allows the TruPulse 200L to deliver accurate and fast measurements.



## Section 2 - Quick Start













1. Install the batteries (page 8).
2. Press  to power ON the TruPulse 200L.
3. Select a target such as a tree or a building. For this example, the target should be approximately 250 feet (82 yards or 75 meters) from you.
4. Look through the eyepiece (Figure #2) and use the crosshair to aim to the target. The in-scope LCD should look similar to Figure #3A.
  - If the  indicator is not displayed, press  or  until the  indicator is displayed.
5. Press-and-hold . The  indicator is displayed while the laser is active (Figure #3B). The laser will remain active for a maximum of 5 seconds while acquiring data about the target.
  - If the target is not acquired, release  and repeat this step.
6. Release  once the distance is displayed (Figure #3C). The measurement will be displayed steady until you press a button or the unit powers OFF.
  - Press  or  to scroll through the measurement modes and see the results acquired for each function.
  - Repeat steps #3-#6 above to take another measurement.
  - Simultaneously press-and-hold  and  for 4 seconds to power OFF the TruPulse 200L.



Figure #2

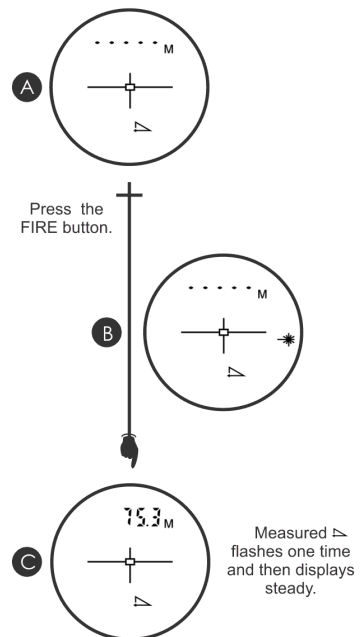

Figure #3

## Section 3 - Basic Operations

### Battery

#### Installation

The TruPulse 200L is powered by a 3 Volt Lithium battery commonly referred to as CR123A or also referred to as CR123.

1. Remove the battery compartment cover by gently pressing the clip to release the cover.
2. Install the battery as shown in Figure #4A. The battery must be oriented (+/-) as shown in the figure and also on the indication sticker found inside the battery compartment.
3. Replace the battery compartment cover by aligning the tab located on the top the cover with the grooved edge of the battery compartment, and press the cover until the tab locks into position.

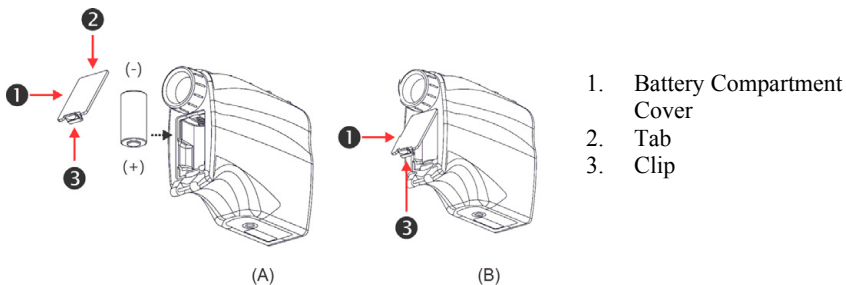

Figure #4

#### Low Battery Warning

The TruPulse 200L monitors the incoming battery voltage. Figure #5 shows the location of the battery status indicator.

- When the voltage drops below 2.6V, the BATT status indicator flashes every 5 seconds, alternating with the normally displayed information.
  - You should replace the batteries as soon as possible.
- When the voltage drops below 2.4V, the BATT status indicator stops flashing and is displayed steady. At this point, system operation is locked.
  - You must replace the batteries to return to normal system operation.

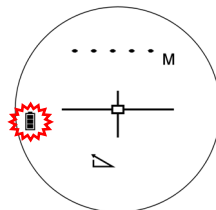







Figure #5

## Buttons

The TruPulse 200L has three buttons. With the TruPulse 200L in your right hand and

looking through the eyepiece,  is located on top, near your index finger.  and  are located on the left side of the instrument.



<b>Measurement Modes</b>	Powers ON the unit. Distance Measurement: fires the laser. Inclination: Release “locks” tilt sensor in (1) Height Measurement Mode and (2) Continuous Target Mode.
<b>Height Routine</b>	 (HD) Fires the laser.  (INC) Release “locks” tilt sensor.
<b>Target Modes System Setup Mode</b>	Selects option and returns to the Measurement Mode.





<b>Measurement Modes</b>	Press to scroll to the previous Measurement Mode.
	Press-and-hold 4 seconds to access the Target Mode.
<b>Height Routine</b>	Clears the last measurement and re-displays the previous prompt.
<b>Target Modes System Setup Mode</b>	Press to scroll to the previous option.



<b>Measurement Modes</b>	Press to scroll to the next Measurement Mode.
	Press-and-hold 4 seconds to access the System Setup Mode.
<b>Height Routine</b>	Exits the Height Routine.
<b>Target Modes System Setup Mode</b>	Press to scroll to the next option.

## Powering OFF the TruPulse 200L

To power OFF the unit, simultaneously press-and-hold  and  for 4 seconds.

To conserve battery power, the TruPulse 200L powers itself OFF if no button presses are detected after 2 minutes.

## Display Indicators

Figure #6 shows the LCD in-scope display. The TruPulse 200L's internal software is organized into options. Each option represents a specific measurement or setup function and has a corresponding display indicator. Refer to the figure and table below for information about each indicator.

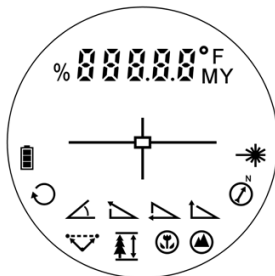















Figure #6

	<b>Main Display</b>	Displays messages and measurement results.
	<b>Percent Slope</b>	Inclination measurement units.
	<b>Degrees</b>	
	<b>Feet</b>	
	<b>Meters</b>	Distance measurement units. Selection available in the System Setup Mode.
	<b>Yards</b>	
	<b>Battery Status</b>	<i>Flashing:</i> battery voltage is low. <i>Steady:</i> battery voltage is too low for system operation. <i>Not Visible:</i> battery voltage is within acceptable range.
	<b>Crosshair</b>	Serves as the aiming point reference, both horizontally and vertically.
	<b>Laser Status</b>	<i>Visible:</i> laser is firing. <i>Not Visible:</i> laser is not active.
	<b>Continuous Target Mode</b>	The unit continuously acquires targets and displays measurements while  is held down. The distance to the most recently acquired target is displayed.

	<b>Inclination Measurement Mode</b>	The angle of inclination between the TruPulse 200L at level and the target.
	<b>Slope Distance Measurement Mode</b>	Straight line distance between the TruPulse 200L and the target.
	<b>Horizontal Distance Measurement Mode</b>	The level distance between the TruPulse 200L and the plane of the target.
	<b>Vertical Distance Measurement Mode</b>	The distance between the target and the perpendicular to the path of the horizontal distance.
	<b>Azimuth</b>	<b>Not available.</b>
	<b>2D Missing Line Measurement Routine</b>	2D Missing Line Routine finds the connecting vector (or missing line) between two points.
	<b>Height Measurement Routine</b>	Three-step height routine. The final calculation represents the vertical distance between the points on the target represented by ANG1 and ANG2.
	<b>Closest Target Mode</b>	The unit logs multiple targets while  is held down. The circle denotes that additional targets have been acquired. Of the targets acquired, the distance to the closest target displays.
	<b>Farthest Target Mode</b>	The unit logs multiple targets while  is held down. The circle denotes that additional targets have been acquired. Of the targets acquired, the distance to the farthest target displays.
<i>No Indicator</i>	<b>Filter Mode</b>	'F' appears as the left-most character of the Main Display to indicate Filter Mode is active. Similar to Standard, single shot mode, but the laser's sensitivity is reduced so it only detects pulses returned from a reflector. The optional foliage filter must be used in conjunction with this mode.

## Display Indicator Test

To verify that all display indicators are working properly:

1. Start with the TruPulse 200L powered OFF, press-and-hold .
2. Compare the in-scope display to the Figure #6 (page 10) to verify that all indicators are working properly.
3. Release  to start normal operation.

## Error Codes

Error conditions can occur in a measurement or in the system hardware. To make sure that you never get an erroneous measurement, the TruPulse 200L monitors both system hardware and measurements. When the instrument detects an error condition, it displays and error code instead of a measurement.

Error codes appear in the main display and are in the form of “Exx”, where “xx” is an error code number. Figure #7 shows an example error code, E36.

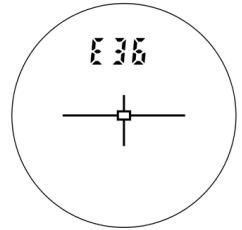





*Figure #7*

 If an error code persists:

1. Release  and press again to try to retake the measurement.
2. Remove and re-install the batteries and then try to retake the measurement.
3. If the above steps do not resolve the error, contact LTI or an Authorized LTI Distributor for assistance. Refer to the inside front cover for LTI contact information.

### Firmware Revision Number and Serial Number

The firmware revision number provides manufacturing information about your TruPulse 200L. To display the firmware revision and serial number:

1. Start with the TruPulse 200L powered OFF, press-and-hold .
  - o Do not release  until done. If you release the button too early, power OFF the TruPulse 200L and repeat step #1.
2. Looking through the eyepiece:
  - o Press  to display the firmware revision number.  
The display should look similar to the example below (1.02 in Figure #8).
  - o Press  to display the instrument serial number.  
The display should look similar to the example below (123 in Figure #8).

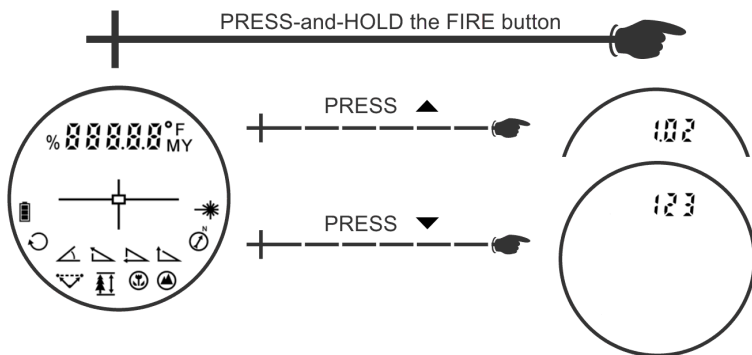
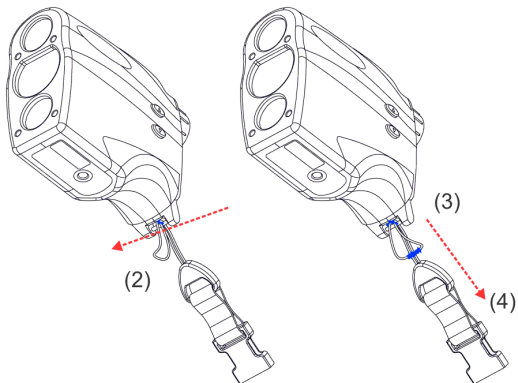

Figure #8

## **Neck Strap**

To attach the neck strap:

1. Disconnect the anchor end of the strap using the buckle.
2. Feed loop around metal bar.
3. Thread the Neckstrap through the loop.
4. Gently tighten to secure.
5. Reconnect anchor end of the strap using the buckle.











*Figure #9*



## Units of Measure

The TruPulse 200L allows you to choose the units of measure. Distance: meters, yards or feet. Inclination: degrees or % Slope. To toggle the units selection:

1. From the Measurement Mode, press  for 4 seconds to access the System Setup Mode. “UnitS” will appear in the Main Display.
2. Press  to select the “UnitS” option.
3. Press  or  to display the previous or next distance unit option.
4. Press  to select the displayed distance unit and display the inclination unit option.
5. Press  or  to display the previous or next inclination unit option.
6. Press  to select the displayed inclination unit and return to the Measurement Mode.

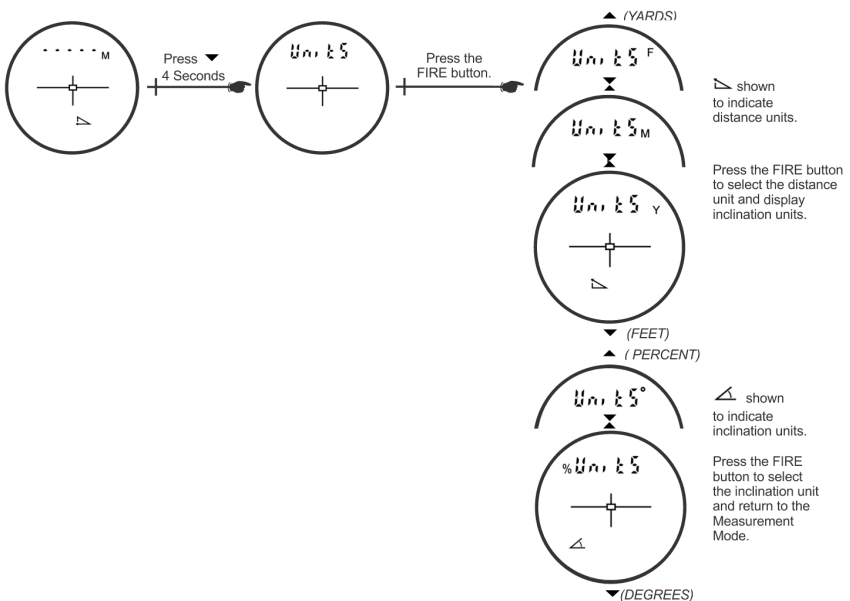





Figure #10

-  Each time the TruPulse 200L is powered ON, it will return to the same unit setting that was last used.

## Section 4 - Measurement Modes

When you power ON the TruPulse 200L, the last used Measurement Mode will be active. Press  or  to display the previous or next Measurement Mode. Figure #11 shows the four different types of measurements that the TruPulse 200L can take.

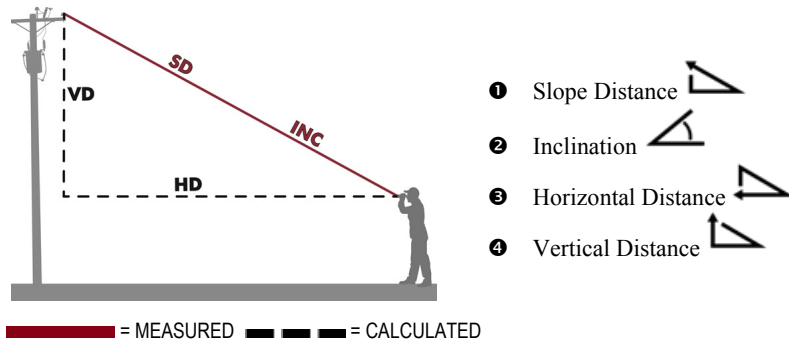





Figure #11







Notes: Figure #11 does not include the Height Routine (HT), refer to [page 18](#).  
Figure #11 does not include the 2D Missing Line (ML), refer to [page 20](#).











### Distance Measurements

The basic steps for taking any distance measurement:





1. Look through the eyepiece and use the crosshair to aim to the target.
2. Press-and-hold . The  indicator is displayed while the laser is active. The laser will remain active for a maximum of 5 seconds while acquiring data about the target.
  - If the target is not acquired in the 5 second period, release  and repeat this step.
3. Once the measurement is displayed, release . The measurement will be displayed steady until you press any button or the unit powers OFF.

## Notes about Measurements

-  Press  or  to scroll through the individual measurement functions and see the results acquired for each function.
- Both inclination and distance are measured in the Horizontal Distance , Slope Distance , and Vertical Distance  modes.
  - Example Range Measurement:
 

		= 12.5 meters
		= 1.6 meters
		= 12.6 meters
		= 7.3 degrees
  - When you scroll to the Height Function , the Main Display will be blank and the  will be flashing.
  - In the Inclination Mode , the Main Display will be blank for all other measurement functions since the laser is not active when measuring inclination only.
  - The last measurement does not need to be cleared before acquiring your next target.
  - Each time the TruPulse 200L is powered ON, it will return to the same measurement mode that was last used.

## Inclination Measurements

The laser is not active in the Inclination  Measurement Mode. Generally, the inclination is measured when you press . However, in (1) the Continuous Target Mode  and (2) in the Height Measurement Mode , the inclination reading appears in the Main Display and the display updates as your aiming point changes as long as you press .

## Percent Slope

Percent slope, indicated by %, is a calculation equal to 100 times the tangent of the inclination angle. It is a variant way of expressing the inclination. You can get percent slopes only in the basic measurement displays, never in the Height measurement displays. Note also that the instrument never downloads a percent slope. It always downloads the inclination angle.

-  An inclination angle of 5 degrees for example is equal to a slope of about 8.7 percent.

## Height Routine

Height Measurements involve a simple routine that prompts you to take 3 shots to the target: Horizontal Distance, Inclination Angle base and Inclination Angle top. The TruPulse 200L uses these results to calculate the height of the target. Figure #12 shows the three shots required for the height routine.

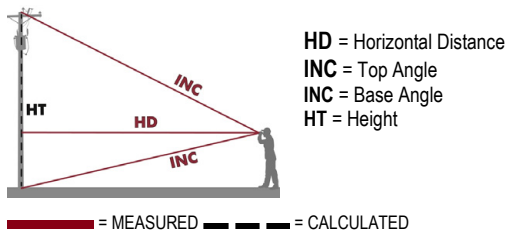

Figure #12

1. Select your target and look through the eyepiece, using the crosshair to aim to your target. The indicator displays steady and the indicator flashes; prompting you to measure the Horizontal Distance to the “face” of the target.
2. Press-and-hold . The indicator is displayed while the laser is active. The laser will remain active for a maximum of 5 seconds while acquiring data about the target. The measured horizontal distance appears briefly in the Main Display and then  $Ang\_1$  appears, and the indicator flashes; prompting you to measure the inclination to base (or top) of the target.
3. Press-and-hold and aim to the base (or top) of the target. The measured inclination appears in the Main Display and is updated as long as you continue to hold . The measured inclination is “locked” when you release . The measured inclination appears briefly in the Main Display and then  $Ang\_2$  appears and the indicator flashes; prompting you to measure the inclination to the top (or base) of the target.

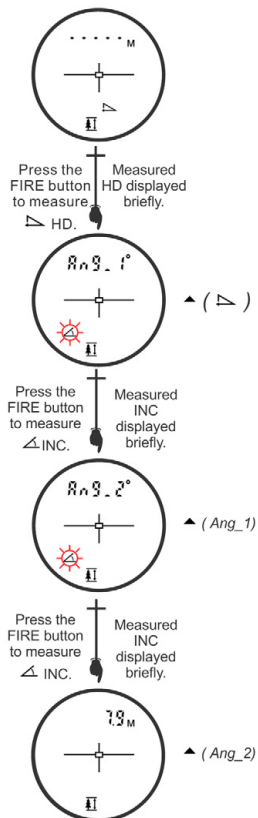









Figure #13

4. Press-and-hold  and aim to the top (or base) of the target. The measured inclination appears in the Main Display and is updated as long as you continue to hold . The measured inclination is “locked” when you release . The measured inclination appears briefly in the Main Display and then the calculated Height is displayed steady until you press any button or the unit powers OFF.

 During the height routine:

- Press  to re-shoot the previous point.
- Press  to exit the height routine.
- The laser is not active while measuring the Ang1 and Ang2 values.

As long as you hold , the inclination reading is displayed and updated as your aiming point changes. The measured inclination is

based upon your aiming point when you release .

- When the height result is displayed, just press  to start the routine and repeat the steps.

## 2D Missing Line Routine

The 2D Missing Line Routine calculates distances and angles to describe the relationship between two points in two-dimensional space (connecting vector). This routine is ideal for remote slope determinations and changes in elevation from one location.

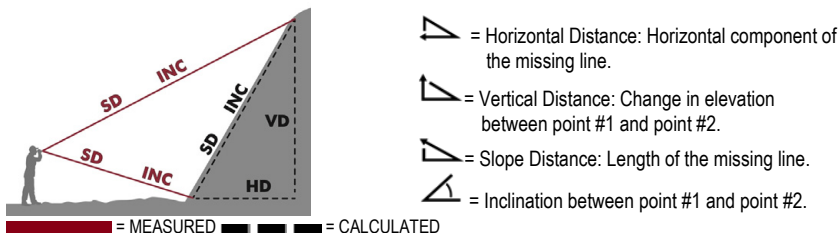

Figure #14

The simple routine prompts you to take two shots to targets: "Shot 1" and "Shot 2". The TruPulse uses the results to calculate four variables between the two points: slope distance, inclination, horizontal distance, and vertical distance as shown in Figure #14.

During the 2D Missing Line Routine:

- Press to re-shoot Shot 1.
  - Press to exit the Missing Line Routine.
1. Select your first target and look through the eyepiece, using the crosshair to aim to your target. The indicator displays steady and the indicator flashes; prompting you to measure the Horizontal Distance to the first target.
  2. Press-and-hold . The indicator is displayed while the laser is active. The laser remains active for a maximum of 5 seconds while acquiring data about the target. The measured horizontal distance appears in the Main Display.
  3. Once the button is released, "SHot2" appears steady and the indicator flashes (with steady); prompting you to measure the Horizontal Distance to the second target. Looking through the eyepiece and using the crosshair to aim to the second target.

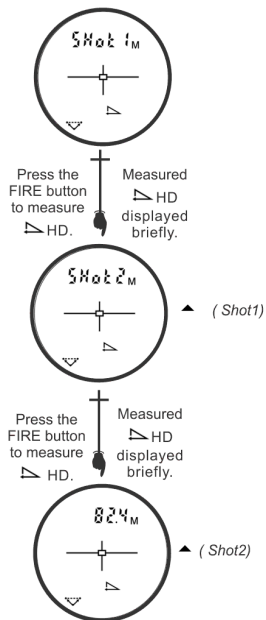















Figure #15









4. Press-and-hold . The  indicator is displayed while the laser is active. The laser remains active for a maximum of 5 seconds while acquiring data about the target. The measured horizontal distance to the second target appears in the Main Display.
5. Once you release ,  and  are steady and the calculated horizontal distance of the missing line is displayed. The measurement displays steady until you press any button or the unit powers off.

At this time, you can:

- Press  or  to scroll and see the other missing line measurements results (,  and ).
- Reshoot Shot 2 by pressing  or  until Shot 2 and ML appear steady in the display as well as HD flashing, prompting you to measure the horizontal distance to the second target (or new target). Go to #4 above.
- Press  to exit the missing line results and return to Shot 1.

## Section 5 - Target Modes

The TruPulse 200L has five Target Modes which allow you to select or eliminate targets and to take the most accurate measurements possible in various field conditions.

- From the Measurement Mode, press  for 4 seconds. The active Target Mode appears in the Main Display.
- Press  or  to display the previous or next Target Mode.
- Press  to select the displayed Target Mode and return to the Measurement Mode.
  - Std = Standard: Single shot mode.
  - Con = Continuous: Press-and-hold . Once the target is acquired, the TruPulse 200L can continuously acquire additional targets for a maximum of 5 seconds. The most recently acquired target appears in the Main Display.
  - CLO = Closest: Press-and-hold . Once the initial target is acquired, the TruPulse 200L can acquire additional targets. The  indicator denotes that additional targets have been acquired. The closest acquired target always appears in the Main Display.
  - FAR = Farthest: Press-and-hold . Once the initial target is acquired, the TruPulse 200L can acquire additional targets. The  indicator denotes that additional targets have been acquired. The farthest acquired target always appears in the Main Display.
  - Flt = Filter: In this mode the laser's sensitivity is reduced to only detect pulses returned from a reflector. The optional foliage filter must be used in conjunction with this mode. In this mode, measurements always include 'F' as the left most character in the Main Display. Typical maximum distance is 350 feet to a 3-inch reflector.

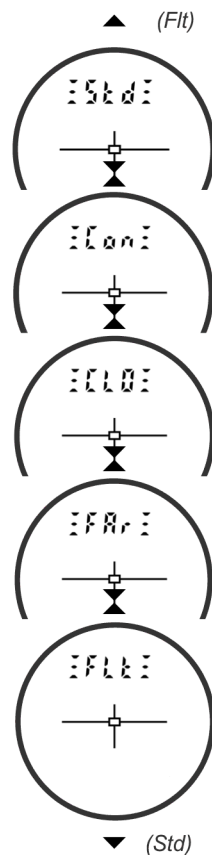

Figure #16



- ① • The selected Target Mode remains active until you repeat the above steps and select a different Target Mode.
- Each time the TruPulse 200L is powered ON, it will return to the same Target Mode that was last used.
- In Closest and Farthest Modes, the minimum separation distance between targets is approximately 20 meters.

## Section 6 - Care & Maintenance

The battery is the only user-replaceable parts in the TruPulse 200L. Do not remove any screws. To do so will effect or void the LTI Limited Warranty.

### *Temperature Range*

The instrument is rated for an operating temperature range of -4 to +140° F (-20 to +60° C). Do not expose the TruPulse 200L to temperatures outside this range.

### *Protecting from Moisture and Dust*

The TruPulse 200L is sealed to provide protection from normally expected field conditions. It is protected from dust and rain, but will not withstand submersion.

-  If water leakage is suspected:
1. Power OFF the TruPulse 200L.
  2. Remove the battery.
  3. Air dry the TruPulse 200L at room temperature with the battery compartment open.

### *Protecting from Shock*

The TruPulse 200L is a precision instrument and should be handled with care. It will withstand a reasonable drop shock. If the unit suffers from a severe drop shock, you may need to send the unit to LTI for service repair.

### *Transporting*

When transporting the TruPulse 200L, the unit should be secured in the provided carrying case. The provided neck strap can be used when carrying the TruPulse 200L in the field.

### *Cleaning*

Clean the TruPulse 200L after each use, before returning it to its carrying case. Check all of the following items:

- *Excess moisture.* Towel off excess moisture, and air dry the instrument at room temperature with the battery removed and the battery compartment open.
- *Exterior dirt.* Wipe exterior surfaces clean to prevent grit buildup in the carrying case. Isopropanol may be used to remove dirt and fingerprints from the exterior.
- *Transmit and Receive Lenses.* Use the provided lens cloth to wipe the lenses. Failure to keep the lenses clean may damage them.

### *Storing*

If you won't be using the TruPulse 200L again soon, remove the battery before storing the instrument.

## Section 7 - Specifications

All specifications are subject to change without notice. Please refer to LTI's website for current specifications. If you are not able to locate the information on the website or if you do not have internet access, please contact LTI via phone or fax.

<b>Weight:</b>	8 ounces (220 g)
<b>Size:</b>	4.5" x 4" x 2" (11.5 cm x 10 cm x 5 cm)
<b>Range Limits:</b>	0 to 5,740 ft (1 m to 1,750 m) max
<b>Range Accuracy:</b>	±1.6 ft (±0.5m) to high quality targets ± 3 ft (± 1m) to low quality targets *Refer to TruTargeting section <a href="#">page 5</a> .
<b>Range Resolution:</b>	0.5 ft, 0.1m, 0.1 yd
<b>Range Units:</b>	Feet, Yards and Meters
<b>Inclination Limits:</b>	±90 degrees
<b>Inclination Accuracy:</b>	± 0.5 degrees
<b>Inclination Resolution:</b>	0.5 degree, 1%
<b>Inclination Units:</b>	Degrees, % Slope
<b>Power:</b>	3.0 volts DC nominal; (1) CR123A battery (Alkaline, NiCd/NiMH, Lithium)
<b>Battery Duration:</b>	8 Hours Continuous Use
<b>Eye Safety:</b>	FDA Class 1 (CFR 21)
<b>Environmental:</b>	Water and dust resistant; IP 54
<b>Temperature:</b>	-4 to +140° F (-20 to +60° C)
<b>Optics:</b>	4X Magnification
<b>Display:</b>	In-scope LCD

## **Section 8 - LTI Limited Warranty**

### **What is Covered?**

Laser Technology, Inc. (LTI) warrants this product to be in good working order. Should the product fail to be in good working order at any time during the warranty period, LTI will, at its option, repair or replace this product at no additional charge.

Parts and products that have been replaced as a result of a warranty claim become the property of LTI.

### **What is the Period of Coverage?**

This warranty remains in force for two years from the date of purchase from LTI or an authorized LTI product dealer; unless otherwise noted by LTI at the time of sale. LTI reserves the right to require written verification of the date of the original purchase of any product.

### **What is Not Covered?**

LTI has no obligation to modify or upgrade any product once sold. Any reproduction of software products is strictly forbidden. This limited warranty does not include service to repair damage to the product resulting from:

- Accident
- Disaster
- Misuse
- Abuse
- Non-LTI modification
- Batteries or damage caused by batteries used in our products.

In no event will LTI be liable to you for any damages, including any lost profits, lost savings, or other incidental or consequential damages arising out of the use or inability to use such product. Furthermore, LTI shall not be held responsible if an LTI authorized dealer has been advised of the possibility of such damage, or for any claim by any other party.

### **What Will We Do to Correct Problems?**

If this product is not in good working order as warranted above, your sole remedy shall be repair or replacement as provided above.

### **How does State Law Relate to this Warranty?**

LTI hereby disclaims all other express and implied warranties for the product, including the warranties of merchantability and fitness for a particular purpose. Some states do not allow the exclusion of implied warranties, so the above limitations may not apply to you.

**How do You Get Service?**

In the unlikely event that your LTI product should require warranty or repair service, contact us to receive a Return Merchandise Authorization (RMA) number before returning your product.

If the product is delivered by mail, you agree to insure the product or assume the risk of loss or damage in transit. In addition, the shipping container or equivalent, will be sent prepaid and for door-to-door delivery.

**Why Should You Complete and Return the Warranty Validation Card to LTI?**

The Warranty Validation Card (shipped in the box with your TruPulse) must be completed and received by LTI in order to benefit from this limited warranty. If an LTI software product requires registration, this must also be completed to benefit from this limited warranty. Receipt of the warranty validation card not only activates the limited warranty, it also allows LTI to contact you directly when hardware or software upgrades become available.

If you prefer to register your LTI product electronically, please

- Visit our website ([www.lasertech.com/Warranty-Registration.aspx](http://www.lasertech.com/Warranty-Registration.aspx))

## Section 9 - Main Display LCD Characters

The LCD Main Display is used to convey messages and measurement results.

When all of the indicators are active the Main Display looks like:



Numbers 0-9:



Alpha Characters:

$\text{A} = a$	$\text{G} = g$	$\text{r} = r$
$\text{d} = d$	$\text{i} = i$	$\text{S} = s$
$\text{E} = e$	$\text{l} = l$	$\text{t} = t$
$\text{F} = f$	$\text{n} = n$	$\text{U} = u$

Due to the limited number of characters available, many messages have to be abbreviated. The table below lists the messages that appear in the Main Display.

Message	Explanation	Page #
$\text{AnG}_1$	Angle 1. Height Routine.	18
$\text{AnG}_2$	Angle 2. Height Routine.	18
$\text{FRr}$	Farthest target mode.	22
$\text{FLt}$	Filter target mode.	22
$\text{Std}$	Standard target mode.	22
$\text{Units}$	Units.	15